

ACOUSTICS

5" SB15MFC30-4

Preliminary data

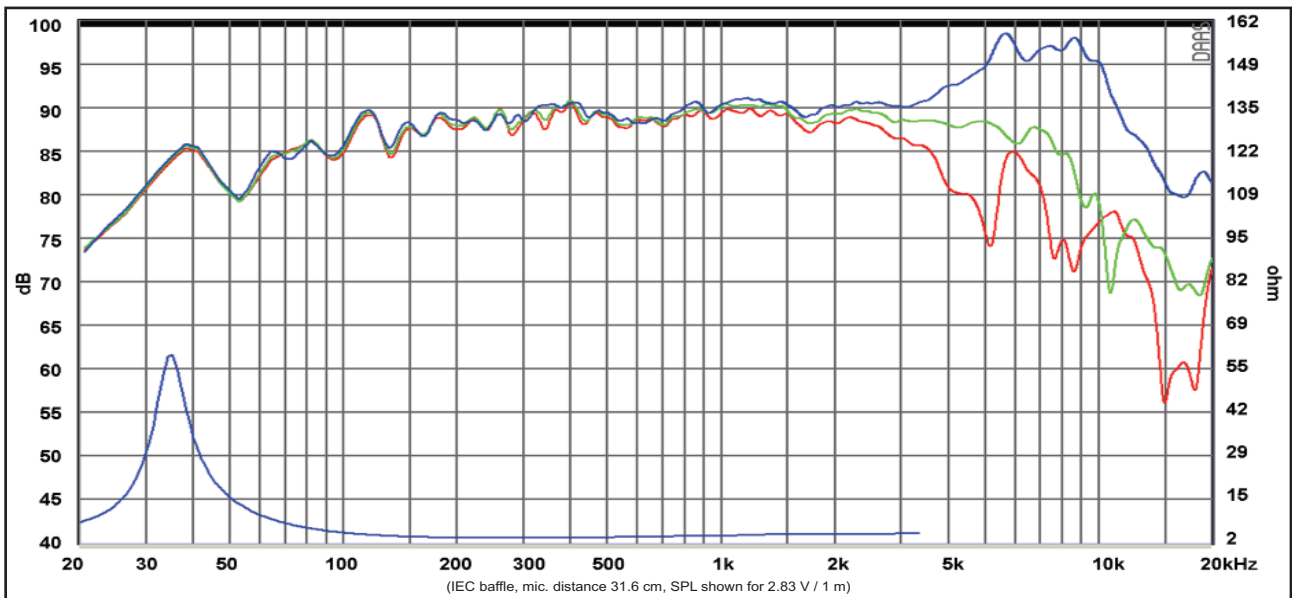
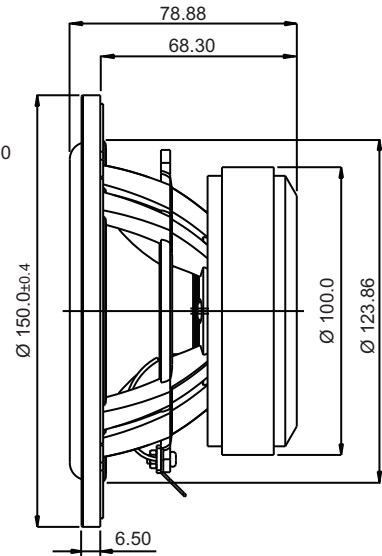
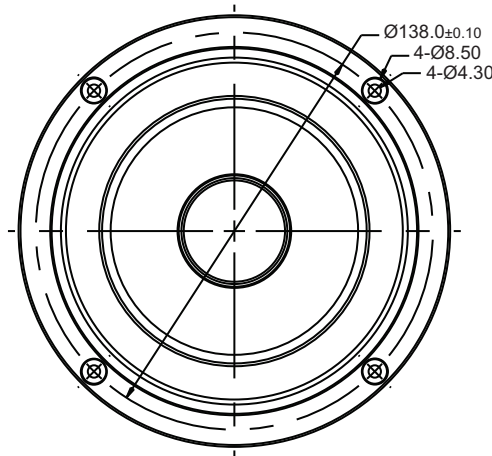

Response Curve :

— (Blue) : on axis — (Green) : 30° off-axis — (Red) : 60° off-axis

Specs :

Nominal Impedance	4 Ω	Free air resonance, Fs	36 Hz
DC resistance, Re	3.1 Ω	Sensitivity (2.83 V / 1 m)	89 dB
Voice coil inductance, Le	0.12 mH	Mechanical Q-factor, Qms	4.5
Effective piston area, Sd	82 cm ²	Electrical Q-factor, Qes	0.32
Voice coil diameter	30.5 mm	Total Q-factor, Qts	0.3
Voice coil height	15 mm	Moving mass incl.air, Mms	10 g
Air gap height	5 mm	Force factor, Bl	4.7 Tm
Linear coil travel (p-p)	10 mm	Equivalent volume, Vas	17 liters
Magnetic flux density	1.0 T	Compliance, Cms	1.8 mm/N
Magnet weight	0.54 kg	Mechanical loss, Rms	0.5 kg/s
Net weight	1.48 kg	Rated power handling*	50 W

* IEC 268-5, T/S parameters measured on drive units that are broken in.